

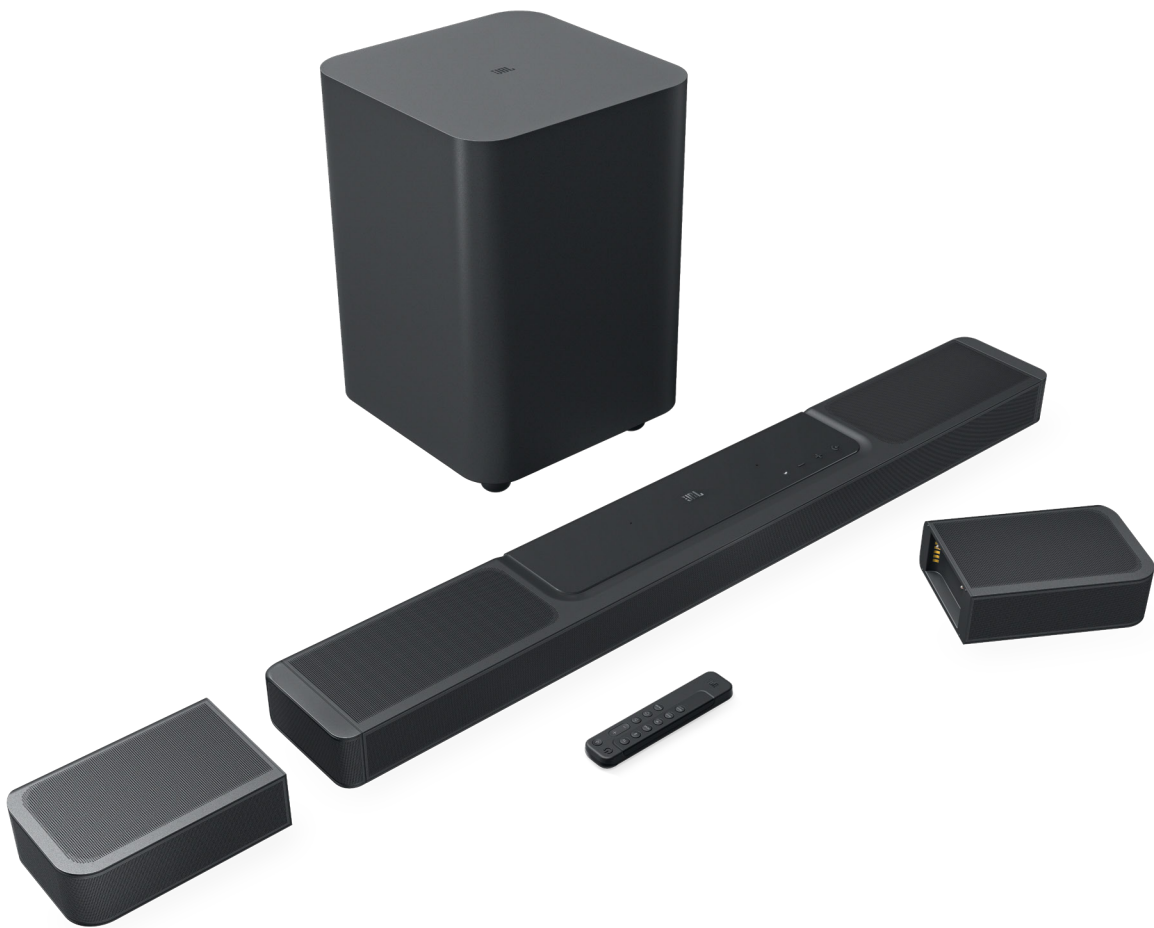

BAR 1300



OWNER'S MANUAL

IMPORTANT SAFETY INSTRUCTIONS

Verify Line Voltage Before Use

The JBL Bar 1300 (soundbar, detachable speakers and subwoofer) has been designed for use with 100-240V AC, 50/60Hz. Connection to a line voltage other than that for which your product is intended can create a safety and fire hazard and may damage the unit. If you have any questions about the voltage requirements for your specific model or about the line voltage in your area, contact your retailer or customer service representative before plugging the unit into a wall outlet.

Do Not Use Extension Cords

To avoid safety hazards, use only the power cord supplied with your unit. We do not recommend that extension cords be used with this product. As with all electrical devices, do not run power cords under rugs or carpets, or place heavy objects on them. Damaged power cords should be replaced immediately by an authorized service center with a cord that meets factory specifications.

Handle the AC Power Cord Gently

When disconnecting the power cord from an AC outlet, always pull the plug; never pull the cord. If you do not intend to use this speaker for any considerable length of time, disconnect the plug from the AC outlet.

Do Not Open the Cabinet

There are no user-serviceable components inside this product. Opening the cabinet may present a shock hazard, and any modification to the product will void your warranty. If water accidentally falls inside the unit, disconnect it from the AC power source immediately, and consult an authorized service center.

TABLE OF CONTENTS

IMPORTANT SAFETY INSTRUCTIONS 2

1. INTRODUCTION 4

2. WHAT'S IN THE BOX 5

3. PRODUCT OVERVIEW 6

- 3.1 SOUNDBAR 6
 - 3.2 DETACHABLE SPEAKERS 6
 - 3.3 SUBWOOFER 7
 - 3.4 REMOTE CONTROL 8
-

4. PLACE 9

- 4.1 DESKTOP PLACEMENT 9
 - 4.2 WALL-MOUNTING 9
-

5. CONNECT 10

- 5.1 CONNECTION WITH YOUR TV AND DIGITAL DEVICES 10
 - 5.2 BLUETOOTH CONNECTION 12
 - 5.3 CONNECTION WITH YOUR HOME NETWORK 13
-

6. SETUP 14

- 6.1 CONNECT THE DETACHABLE REAR SPEAKERS AND SUBWOOFER 14
 - 6.2 CHARGE THE DETACHABLE SPEAKERS 14
 - 6.3 3D SURROUND SOUND 15
 - 6.4 USE THE DETACHABLE SPEAKERS AS STANDALONE BLUETOOTH SPEAKERS 17
-

7. PLAY 19

- 7.1 POWER-ON/AUTO STANDBY/AUTO WAKEUP 19
- 7.2 PLAY FROM THE TV SOURCE 19
- 7.3 PLAY FROM THE HDMI IN SOURCE 20
- 7.4 PLAY FROM THE BLUETOOTH SOURCE 20
- 7.5 PLAY THROUGH THE JBL ONE APP 21
- 7.6 PLAY THROUGH CHROMECAST BUILT-IN 21

- 7.7 PLAY THROUGH AIRPLAY 22
 - 7.8 PLAY THROUGH ALEXA CAST 22
 - 7.9 MULTI-ROOM PLAYBACK 23
-

8. SOUND SETTINGS 24

- 8.1 AUDIO SYNC 24
 - 8.2 SMART MODE 24
-

9. RESTORE FACTORY SETTINGS 24

10. SOFTWARE UPDATE 25

11. RE-CONNECT THE SUBWOOFER 25

12. PRODUCT SPECIFICATIONS 26

13. TROUBLESHOOTING 27

14. TRADEMARKS 29

15. OPEN SOURCE LICENSE NOTICE 30

1. INTRODUCTION

Thank you for purchasing the JBL Bar 1300 (soundbar, detachable speakers and subwoofer) which is designed to bring an extraordinary sound experience to your home entertainment system. We encourage you to take a few minutes to read through this manual, which describes the product and includes step-by-step instructions for setting up and getting started.

To make the most of product features and support, you may need to update the product software through the Internet in the future. Refer to the software update section in this manual to ensure that your product has the latest software.

Designs and specifications are subject to change without notice. If you have any questions about the soundbar, installation or operation, please contact your retailer or customer service representative, or visit our website: www.jbl.com.

JBL One app

With the JBL One app, you can

- easily complete Wi-Fi setup on the soundbar, which allows the soundbar to access software updates when they are available;
- connect *music streaming services;
- discover new music with integrated music services;
- use one button to access your preset playlist and speaker settings.

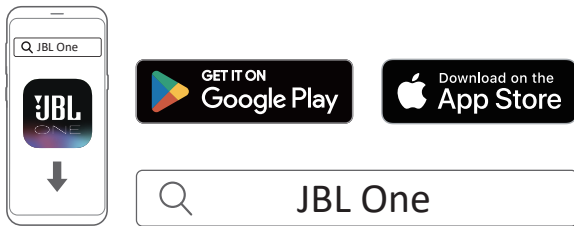

For more information, see [“5.3 Connection with your home network”](#) and [“7.5 Play through the JBL One app”](#).

NOTES:

- *Subscription may be needed and not provided by the JBL One app.

2. WHAT'S IN THE BOX

Unpack the box carefully and ensure that the following parts are included. If any part is damaged or missing, do not use it and contact your retailer or customer service representative.

Soundbar

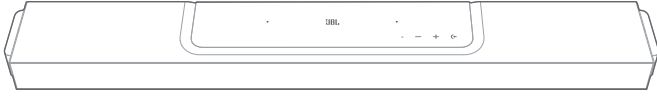

Subwoofer

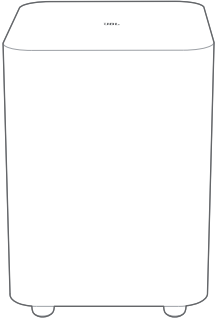

Detachable speakers (with a rechargeable battery)

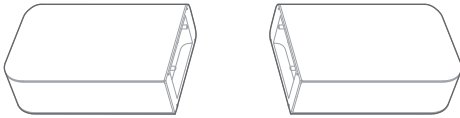

Remote control (with 2 AAA batteries)

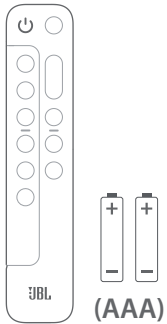

Power cord*

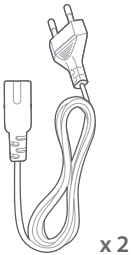

x 2

* Power cord quantity and plug type vary by regions.

HDMI cable (1.2 m/3.9 ft.)



Side caps

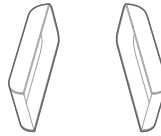

(For the soundbar)

Wall-mounting kit

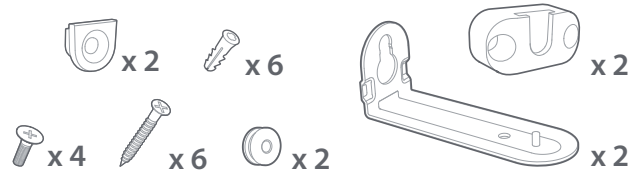

Product information & wall-mounting template



3. PRODUCT OVERVIEW

3.1 Soundbar

3.1.1 Controls

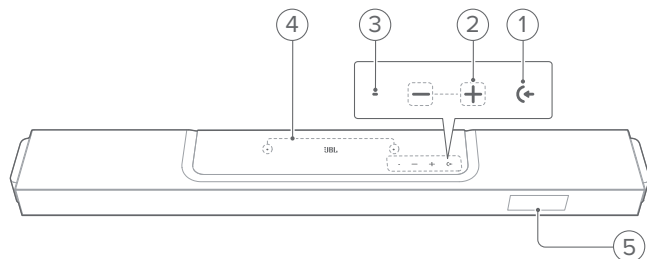

1) (Source)

- Switch on
- Select a sound source: TV (default, for audio input from TV connection where the **HDMI OUT (TV ARC/ TV eARC)** connector is prioritized over the **OPTICAL** connector), Bluetooth or HDMI IN

2) (Volume)

- Switch on
- Decrease or increase the volume
- Press and hold to decrease or increase the volume continuously
- Press the two buttons together to mute or unmute

3) Status indicator

System:		
	Regular flashing (white)	System startup
	Fast flashing (white)	Software updating in progress
	Solid (amber)	Restoring factory settings
Network connection:		
	Slow breathing (white)	Entering Wi-Fi setup mode, or network disconnected
	Solid (green)	Soundbar discovered by the JBL One app
	Solid (white)	Network connected
	Solid (yellow)	Weak Wi-Fi connection

4) Microphone

- For sound calibration

5) Status display

3.1.2 Rear connectors

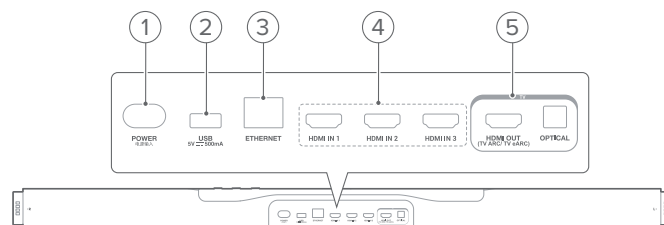

1) POWER

- Connect to power (with the supplied power cord)

2) USB

- USB connector for software update (for service only)
- Connect to USB storage device for MP3 file playback (for US version only)

3) ETHERNET

- Connect to your home network through an Ethernet cable

4) HDMI IN (1/ 2/ 3)

- Connect to the HDMI output on your digital device

5) TV connectors

HDMI OUT (TV ARC/ TV eARC)

- Connect to the HDMI ARC / HDMI eARC input on your TV

OPTICAL

- Connect to the optical output on your TV or digital device

3.2 Detachable speakers

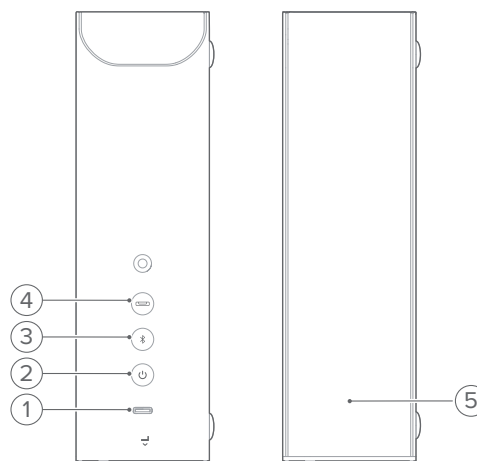

1) USB Type-C connector

- For battery charging

2) (Power)

- Press to switch on
- Press and hold for more than 3 seconds to switch off

3) (Bluetooth mode)

- Press to switch to the Bluetooth mode (for the detachable speakers to work as standalone Bluetooth speakers)

- Source indicator

<input checked="" type="radio"/>	Solid (blue)	Bluetooth mode selected
----------------------------------	--------------	-------------------------

- In the Bluetooth mode, press to enter the Bluetooth pairing mode
- In the Bluetooth mode, press and hold for more than 5 seconds to enter the Bluetooth Stereo pairing mode (to connect to the other detachable speaker and set up a Bluetooth stereo system)



4) (soundbar mode)

- Press to switch to the soundbar mode (for the detachable speakers to work as the rear surround speakers of the soundbar)
- Source indicator

<input type="radio"/>	Solid (white)	Soundbar mode selected
-----------------------	---------------	------------------------

5) Status indicator



- For battery power

	Flashing (red)	Low battery
	Solid (red)	Battery charging in progress

- For wireless connection status

<input type="radio"/>	Slow flashing (white)	Disconnected from the soundbar
	Fast flashing (white)	Connecting to the soundbar
<input type="radio"/>	Solid (white)	Connected to the soundbar

- For Bluetooth connection status

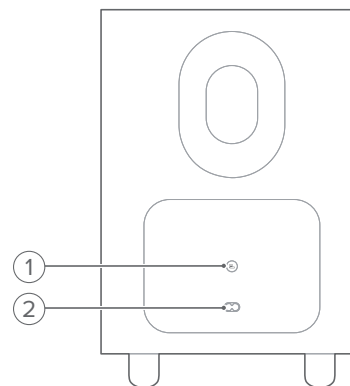

	Regular flashing (blue)	Bluetooth pairing
<input checked="" type="radio"/>	Solid (blue)	Bluetooth connected
	Slow flashing (blue)	Bluetooth not connected
	Regular flashing (cyan)	Connecting to the other detachable speaker (Bluetooth Stereo pairing mode)
<input checked="" type="radio"/>	Solid (cyan)	Connected to the other detachable speaker (Bluetooth Stereo connected)

3.3 Subwoofer



1)

- Connection status indicator





<input type="radio"/>	Solid (white)	Connected to the soundbar
	Fast flashing (white)	Pairing mode
	Slow flashing (white)	Reconnecting or exiting the pairing mode
<input checked="" type="radio"/>	Solid (amber)	Standby mode

2) Power connector

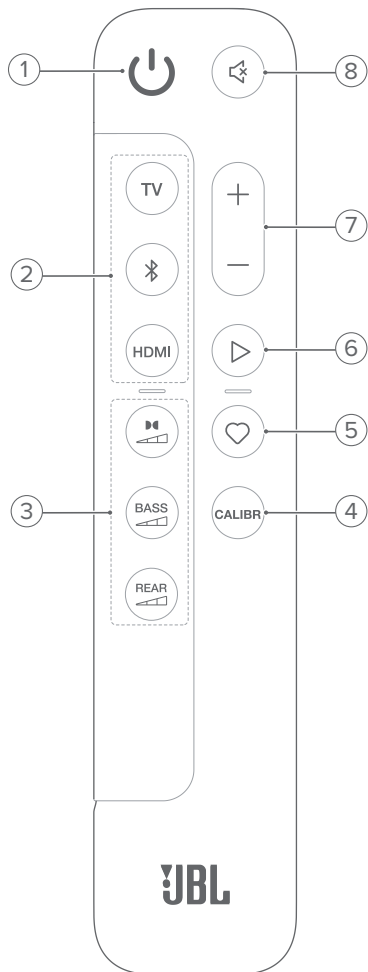
- Connect to power (with the supplied power cord)



3.4 Remote control



- 1) 
 - Switch on or to standby
- 2) **Source selectors**
 - TV**
 - Select the TV source (default, for audio input from TV connection where the **HDMI OUT (TV ARC/ TV eARC)** connector is prioritized over the **OPTICAL** connector)
 -  **(Bluetooth)**
 - Select the Bluetooth source
 - Press and hold to enter the Bluetooth pairing mode
 - HDMI**
 - Repeatedly press to switch between the **HDMI IN** sources: HDMI 1 (default)/ 2/ 3
- 3) **Sound effect buttons**
 - 
 - Select the level of Dolby Atmos/DTS:X effect: middle (default), high or low
 - BASS** 
 - Select the bass level for subwoofer: 1/2/3 (default)/4/5

REAR  (available when both of the detachable rear speakers are undocked from the soundbar)

- Select the surround sound level for rear speakers: middle (default), high, muted or low

- 4) **CALIBR**
 - Press to start sound calibration
- 5)  **(Moment)**
 - Press to directly access the playlist or speaker settings that you have personalized in the JBL One app
- 6)  **(Playback controls during the music streaming over JBL One app, Chromecast built-in™, AirPlay, Alexa Cast or Bluetooth)**
 - Single press: Pause or resume playback
 - Double press: Next track
 - Triple press: Previous track
- 7) **+ / -**
 - Increase or decrease the volume
 - Press and hold to increase or decrease the volume continuously.
- 8)  **(Mute)**
 - Mute/unmute

3.4.1 App-enabled control

With the JBL One app on your Android and iOS device, you can do the following:

- Wi-Fi setup;
- Audio calibration & demo;
- Personalize audio settings;
- Manage and control device;
- Music service integration;
- Additional features.

4. PLACE

4.1 Desktop placement

Place the soundbar, detachable speakers and subwoofer on a flat and stable surface. Refer to the recommended distance in the following diagram.

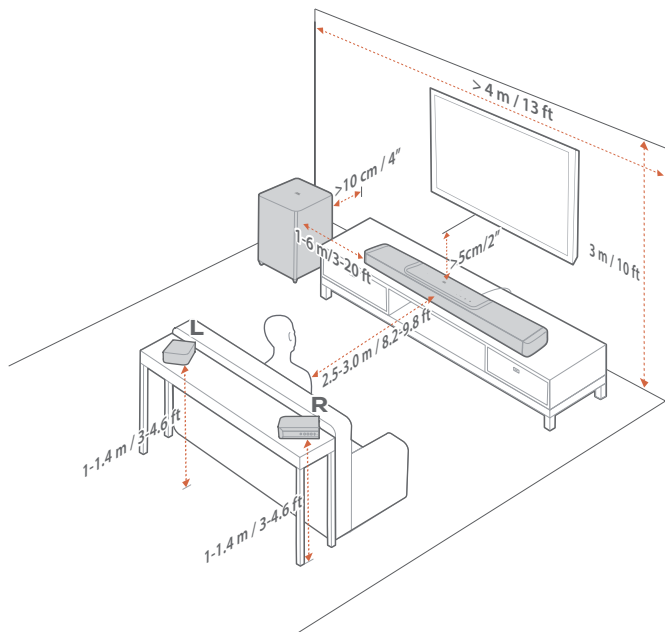

NOTES:

- The power cord shall be properly connected to power.
- Do not place any objects on the top of the soundbar, detachable speakers or subwoofer.
- Charge the detachable speakers in time to ensure sufficient battery power (See “[6.2 Charge the detachable speakers](#)”).
- Use the supplied side caps to cover the two ends of the soundbar after you detach the rear surround speakers (See Step 5 under “[4.2.2 Wall-mount the detachable speakers as rear surround speakers](#)”).

4.2 Wall-mounting

Wall-mount the soundbar and detachable rear speakers together or separately.

4.2.1 Wall-mount the soundbar

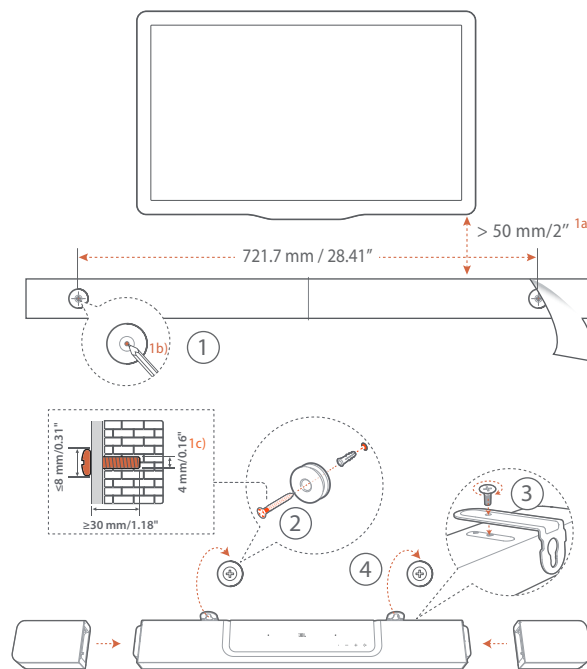

1. Preparation:

- With the distance of about 2" (50mm) from your TV, stick the supplied wall-mounting template to a wall by using adhesive tapes.
- Use your ballpen tip to mark the screw holder location. Remove the template.
- On the marked location, drill a 4 mm/0.16" hole.

2. Install the support for wall-mounting bracket.

- With the screw, fasten the L-shaped wall-mounting bracket onto the bottom of the soundbar.

4. Mount the soundbar.

- After the soundbar is securely wall-mounted, dock the two detachable speakers onto the soundbar.

NOTES:

- Make sure that the wall can support the weight of the soundbar.
- Install on a vertical wall only.
- Avoid a location under high temperature or humidity.
- Before wall-mounting, make sure that cables can be properly connected between the soundbar and external devices.
- Before wall-mounting, make sure that the soundbar is unplugged from power. Otherwise, it may cause an electric shock.
- To move the soundbar, first remove the two detachable speakers to avoid accidental damage.
- Use the supplied side caps to cover the two ends of the soundbar after you detach the rear surround speakers (See Step 5 under “[4.2.2 Wall-mount the detachable speakers as rear surround speakers](#)”).

4.2.2 Wall-mount the detachable speakers as rear surround speakers

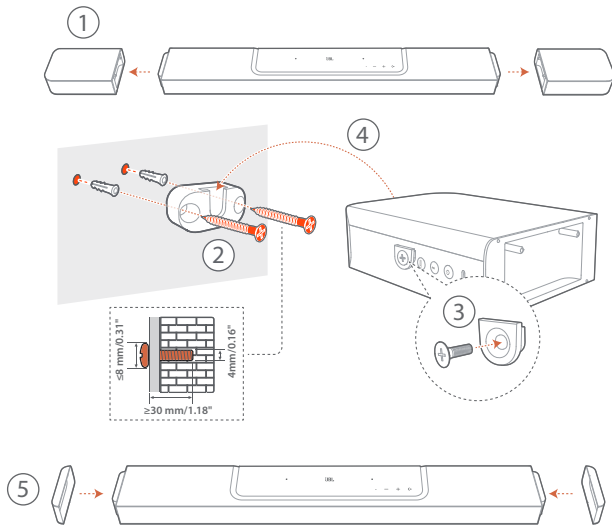

1. From the soundbar, undock the two detachable speakers.
2. Install the wall-mounting bracket.
3. Fasten the support onto the back of the speakers.
4. Mount the speakers.
5. Install the side caps as needed.

5. CONNECT

5.1 Connection with your TV and digital devices

For audio playback through the soundbar, connect the soundbar with your TV through the supplied HDMI cable or an optical cable (sold separately).

An HDMI connection supports digital audio and video with a single connection. HDMI connectivity is the best option for your soundbar.

5.1.1 TV (HDMI ARC / eARC)

(Recommended connection for the best Dolby Atmos / DTS:X experience)

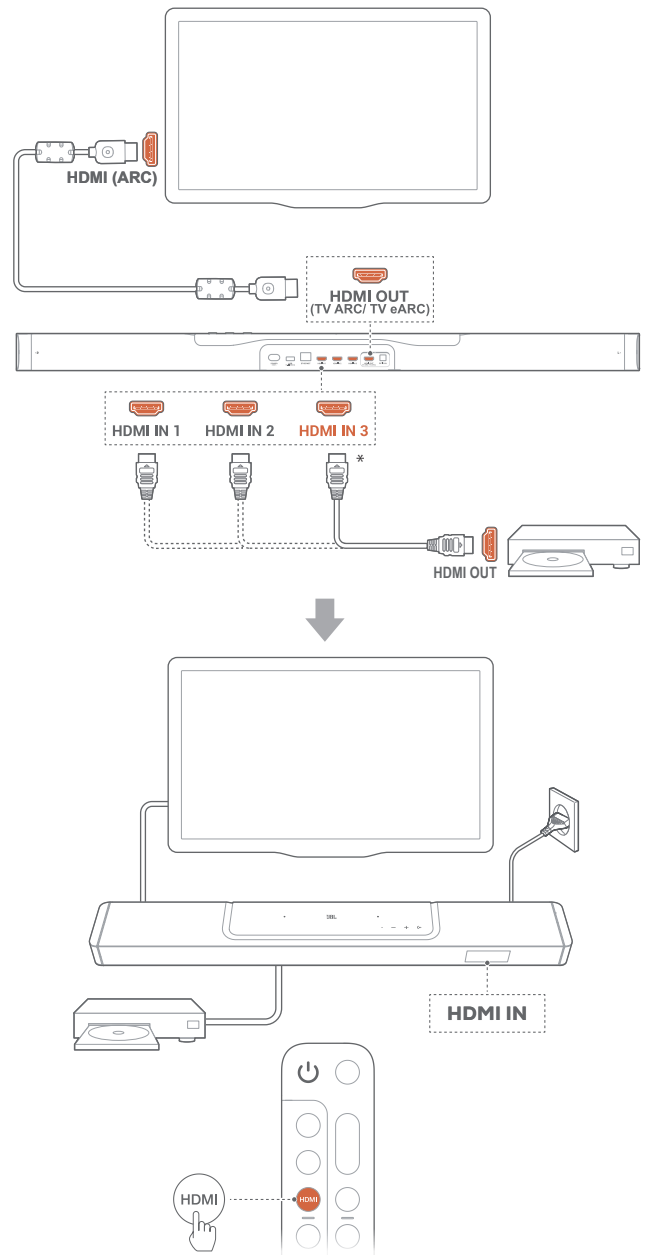

1. Connect the soundbar with the **HDMI IN (ARC / eARC)** connector on your TV by using the supplied HDMI cable.
 - On your TV, check that HDMI-CEC and HDMI ARC / eARC have been enabled. Refer to the owner's manual of your TV for more information.
2. Use an HDMI cable (V2.0 or later) to connect the soundbar with your digital device, such as a set-top box, DVD/Blu-ray player or game console.
 - On your digital device, check that HDMI-CEC has been enabled. Refer to the owner's manual of your digital device for more information.
 - On your digital device, select "Bitstream" or "Raw data" in the audio output settings for the best Dolby Atmos experience.
3. To play audio from the digital device connected to the soundbar, repeatedly press **HDMI** on the remote control to select the HDMI source.

NOTES:

- If your TV does not support HDMI eARC, make sure that you connect your digital device through the HDMI IN connector on the soundbar instead of your TV. Otherwise, the Dolby Atmos information cannot pass through the HDMI (ARC) connectors from the TV to the soundbar.

5.1.2 TV (HDMI eARC)

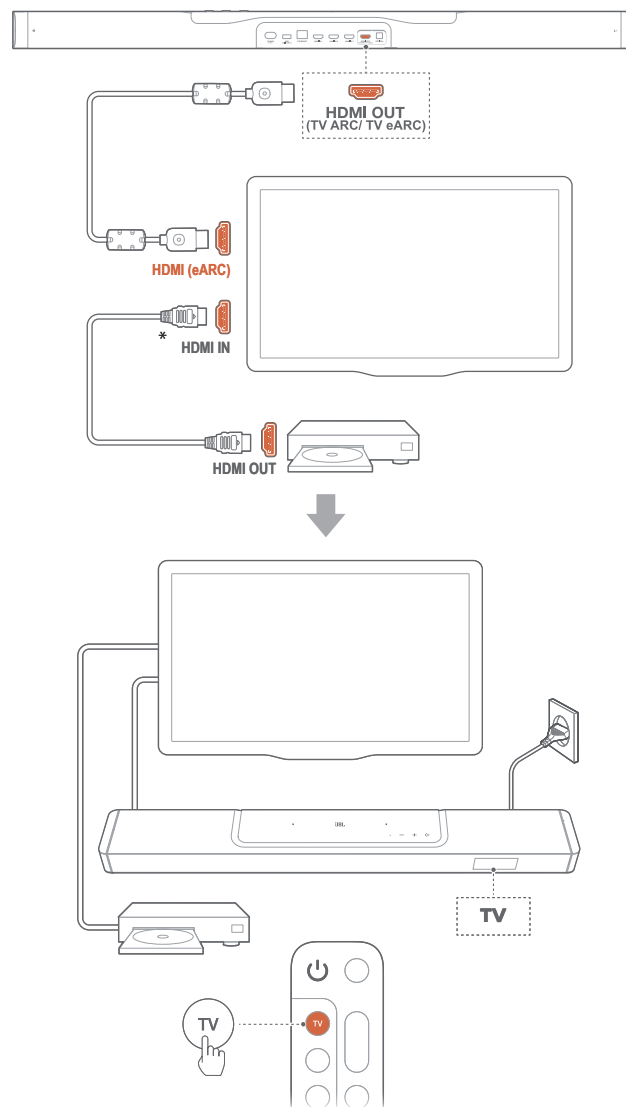

1. Connect the soundbar with the **HDMI IN (eARC)** connector on your TV by using the supplied HDMI cable.
 - On your TV, check that HDMI-CEC and HDMI ARC / eARC have been enabled. Refer to the owner's manual of your TV for more information.
2. Use an HDMI cable (eARC compatible, V2.0 or later) to connect your TV with your digital device, such as a streaming device, set-top box, DVD/Blu-ray player or game console.
 - On your digital device, check that HDMI-CEC has been enabled. Refer to the owner's manual of your digital device for more information.
 - On your TV and digital device, select "Bitstream" or "Raw data" in the audio output settings for the best Dolby Atmos experience.
3. To play audio from the digital device connected to your TV, select **TV** on the remote control.

5.1.3 OPTICAL

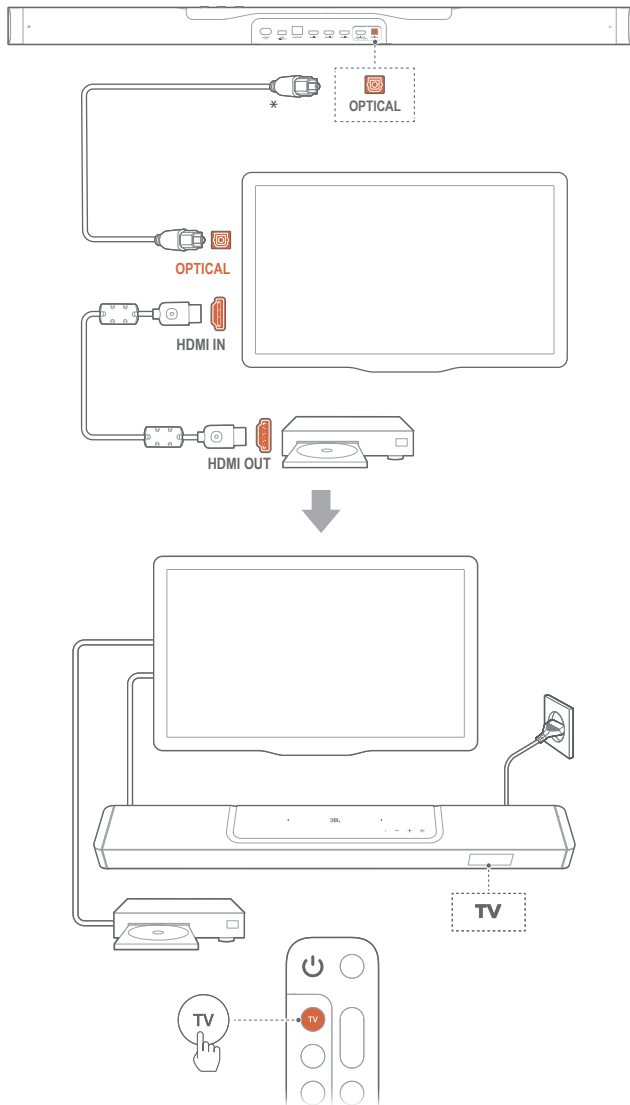

NOTES:

- With the 6 up-firing speakers and the detachable surround speaker design, the Dolby surround upmixer of the soundbar can expand the legacy channel-based audio of Dolby Digital format, including 5.1 and 7.1 content, and provide an immersive 3D Atmos experience.
1. Connect the soundbar with your TV by using an optical cable.
 2. Use an HDMI cable (V2.0 or later) to connect your TV with your digital device, such as a streaming device, set-top box, DVD/Blu-ray player or game console.
 3. To play audio through the optical cable, select **TV** on the remote control.

NOTES:

- * The HDMI cable (for digital device connection) and the optical cable are sold separately.
- Full compatibility with all HDMI-CEC devices is not guaranteed.
- When both HDMI ARC and optical cables are connected to the soundbar for audio input from TV connection, the HDMI ARC connection is prioritized.

5.2 Bluetooth connection

Through Bluetooth, connect the soundbar with your Bluetooth device, such as a smartphone, tablet and laptop.

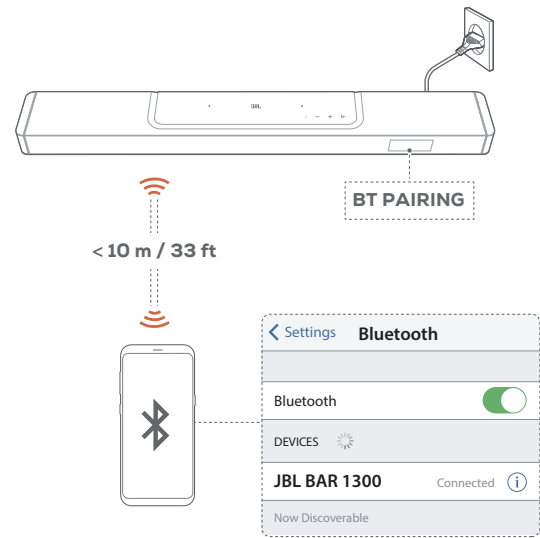

5.2.1 Connect a Bluetooth device

1. To select Bluetooth source, press **⏮** on the soundbar or **📶** on the remote control.
 - **"BT PAIRING"**: Ready for BT pairing
2. On your Bluetooth device, enable Bluetooth and search for **"JBL BAR 1300"** within three minutes.
 - **Successful connection**: The device name is displayed if your device is named in English. A confirmation tone is heard.

5.2.2 To reconnect the last paired device

Your Bluetooth device is retained as a paired device when the soundbar goes to standby mode. Next time you switch to the Bluetooth source, the soundbar reconnects the last paired device automatically.

5.2.3 To connect to another Bluetooth device

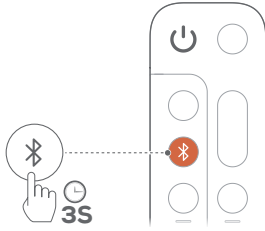

1. In the Bluetooth source, press and hold **⏪** on the soundbar or **⏪** on the remote control until **"BT PAIRING"** is displayed.
→ The soundbar enters the Bluetooth pairing mode.
2. Follow the Step 2 under ["5.2.1 Connect a Bluetooth device"](#).
 - If the device has ever been paired with the soundbar, first unpair **"JBL BAR 1300"** on the device.

NOTES:

- The Bluetooth connection will be lost if the distance between the soundbar and Bluetooth device exceeds 33 ft (10 m).
- Electronic devices may cause radio interference. Devices that generate electromagnetic waves must be kept away from the soundbar, such as microwaves and wireless LAN devices.

5.3 Connection with your home network

Through Wi-Fi or an Ethernet cable, connect the soundbar to your home network. With the JBL One app and the supported streaming services (Chromecast built-in, AirPlay and Alexa Cast), the soundbar allows you to stream audio on smartphones or tablets through the soundbar speakers.

1. On the soundbar, enter the Wi-Fi setup mode:
 - Press any button to switch on (See ["7.1 Power-on/Auto standby/Auto wakeup"](#)).
 - If the soundbar has not been connected to a network, the screen shows **"HELLO"** and then, **"SETUP WIFI"**.
 - To re-enter the Wi-Fi setup mode, press and hold **+** and **-** until **"SETUP WIFI"** is displayed.
2. On your Android or iOS device, add the soundbar to your home Wi-Fi network through the JBL One app.
 - a) Connect your Android or iOS device to your home Wi-Fi network. Download the JBL One app.
 - b) Follow the app instructions to complete setup.

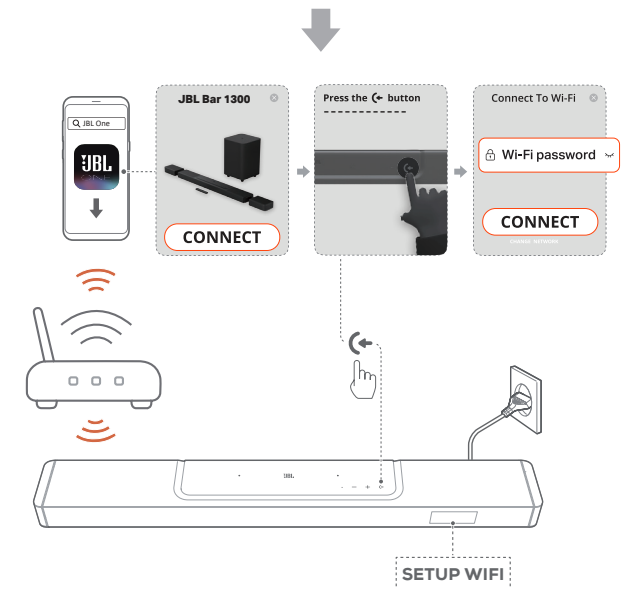
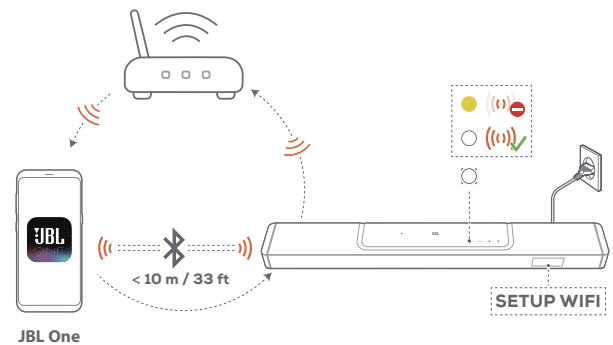

3. If necessary, use an Ethernet cable to connect the soundbar to your home network.
 - Make sure that you connect to the same network as you did during the setup.

NOTES:

- On your Android or iOS device, you can name the soundbar in the JBL One app.
- On your iOS device, add the soundbar to the Apple Home app and manage it together with other AirPlay-compatible speakers.
- On your iOS device, if the soundbar has been added to your home Wi-Fi network, you can start AirPlay streaming from an AirPlay-compatible app (See ["7.7 Play through AirPlay"](#)).
- Availability of online music streaming services varies by country.
- Some features require subscriptions or services not available in all countries.

6. SETUP

6.1 Connect the detachable rear speakers and subwoofer

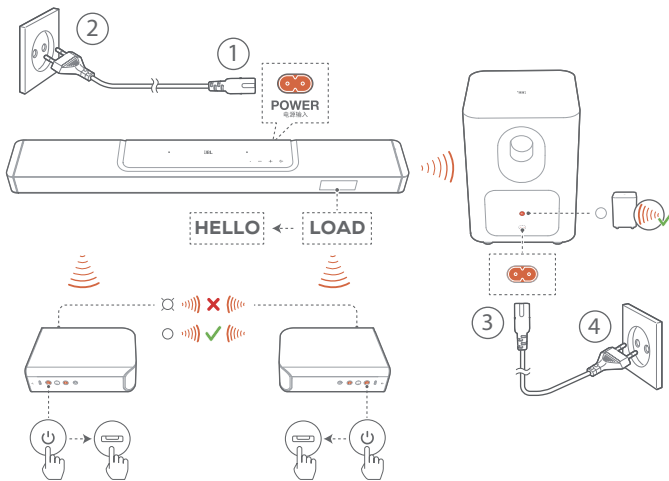

1. Connect the soundbar to power by using the supplied power cord.
 - The screen on the soundbar shows “LOAD” and then, “HELLO”.
2. Do the following to start the connection:
 - Connect the subwoofer to power by using the supplied power cord;
 - Dock the detachable speakers onto the soundbar, or press and then, on the detachable speakers to fast re-connect to the soundbar.
 - The soundbar connects the subwoofer automatically.
Connected: turns solid white on the subwoofer.
 - The soundbar connects the detachable speakers automatically.
Connected: The status indicator turns solid white on the detachable speakers.

NOTES:

- Use the supplied power cords only.
- Before connecting to power, make sure that you have completed all other connections (See “[5.1 Connection with your TV and digital devices](#)”).

6.2 Charge the detachable speakers

When the detachable surround speakers are out of battery, their wireless connection with the soundbar will be lost.

The first time you use the two detachable speakers, charge them for about 4 hours to ensure sufficient battery power.

- When the battery power runs low, the status indicator flashes red on the detachable surround speakers and “REAR SPKR LOW BATT” is displayed on the soundbar.
- When the battery power runs out, “DOCK REAR SPKR” is displayed on the soundbar.

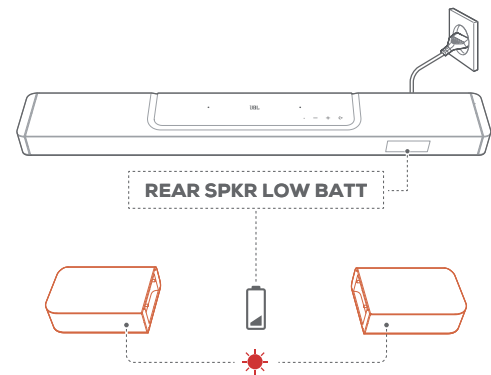

6.2.1 Charge by docking the detachable speakers

Charging starts when you dock the detachable speakers onto the soundbar.

- When the soundbar switches to standby mode, turns on; turns off when the detachable speakers are fully charged.
- It takes about 4 hours for the empty battery to be fully charged.

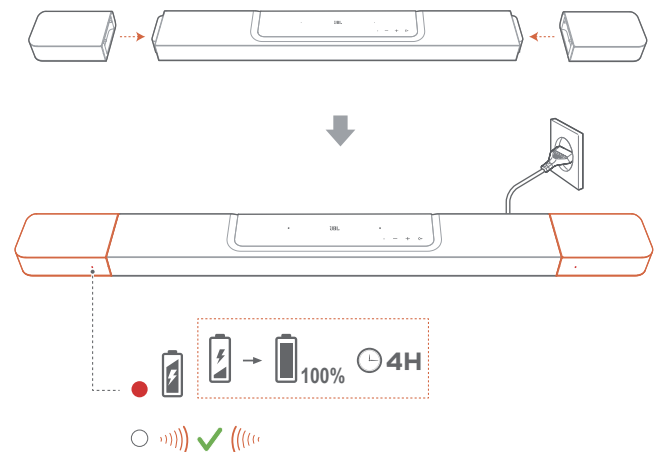

6.2.2 Charge through a USB cable

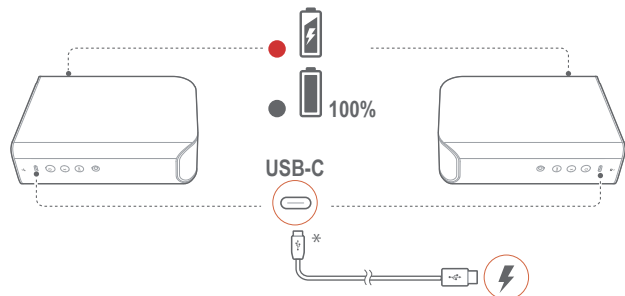

- Use a USB-C cable to connect the detachable speakers to power respectively.
- For the detachable speakers, the status indicator is used for status indication of both battery power and wireless connection (See “[3.2 Detachable speakers](#)”).

NOTES:

- * The USB-C cable is sold separately.

6.3 3D surround sound

6.3.1 Sound calibration

Optimize your 3D surround sound experience for your unique listening environment.

For sound calibration, do the following:

- Make sure that your room is quiet;
- Make sure that the soundbar and the two detachable rear speakers are fully in sight of each other, without obstacles in between.
- Make sure that the left and right rear speakers are properly placed, the **L** speaker on the left and the **R** speaker on the right.

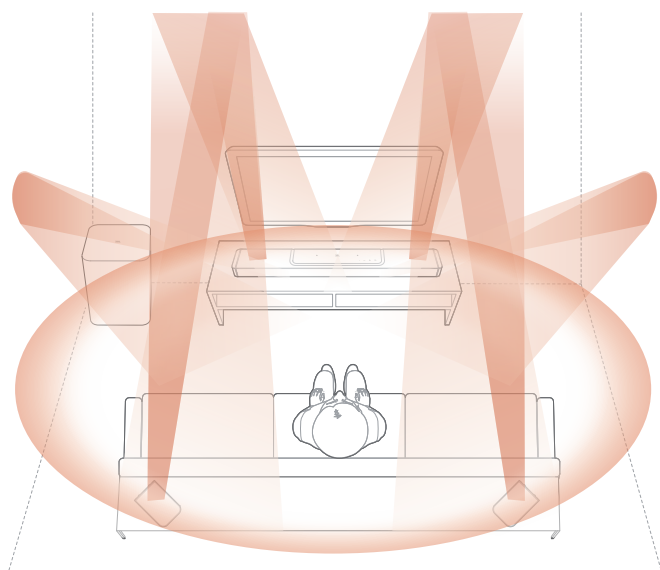

1) Calibrate the listening zone

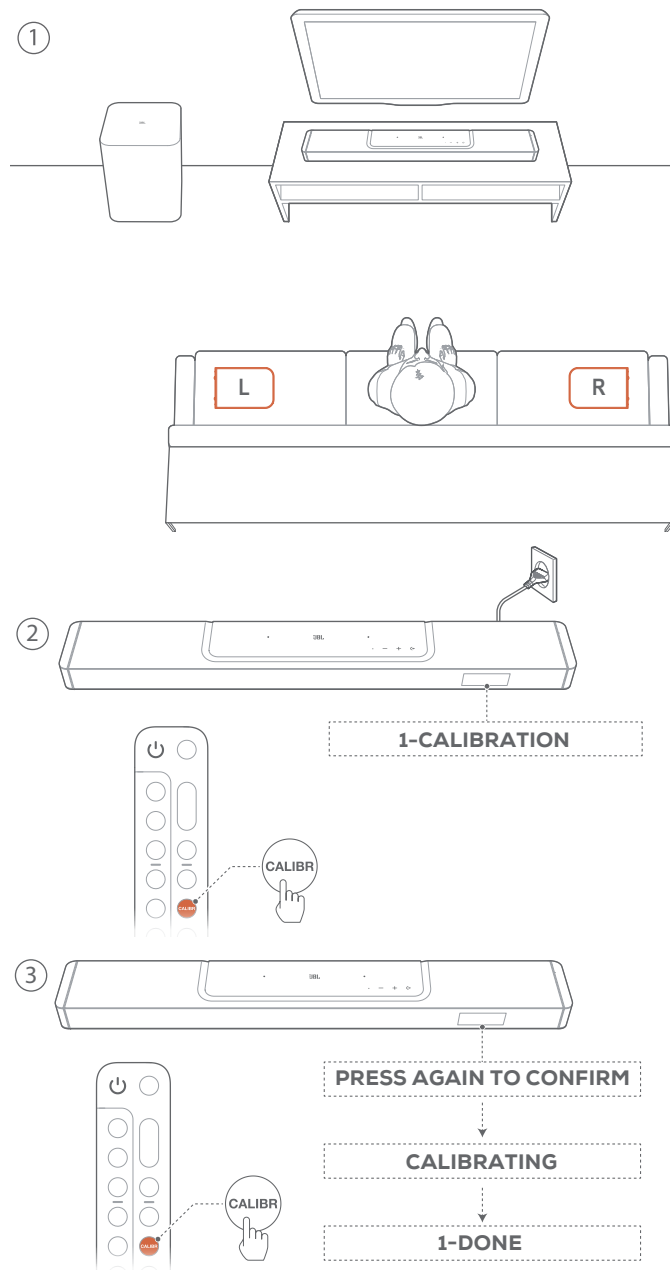

1. Place the detachable rear speakers beside your seating position.
 - Make sure that the two detachable speakers have been connected to the soundbar (See “[6.1 Connect the detachable rear speakers and subwoofer](#)”).
2. On the remote control, press **CALIBR** to start calibration.
 - “**1-CALIBRATION**” is displayed on the soundbar.
3. When “**PRESS AGAIN TO CONFIRM**” is displayed, press **CALIBR** again.
 - Countdown starts from 5 to 1.
 - Calibration tone is heard. Audio calibration starts.
 - “**CALIBRATING**”: Calibration in progress
 - “**1-DONE**”: Calibration of the listening zone is completed successfully.

2) Calibrate the speaker position

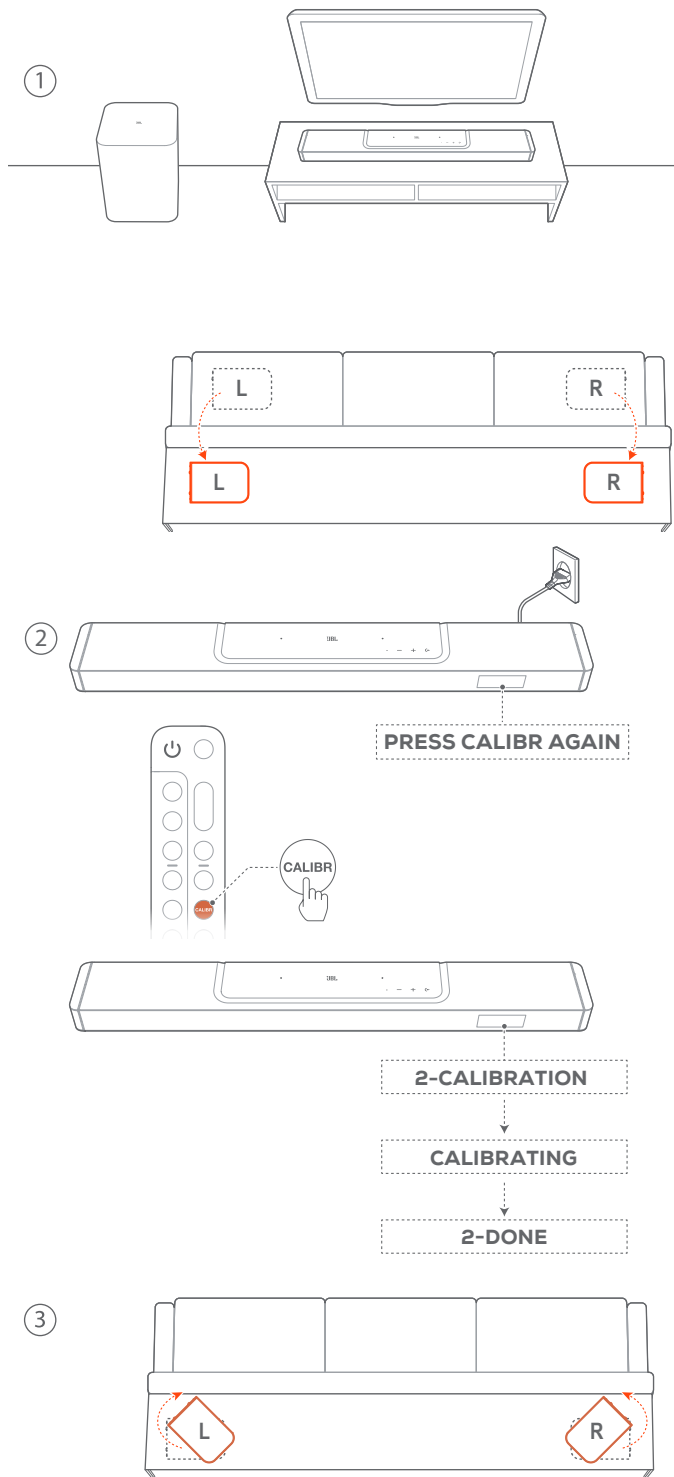

1. Place the detachable rear speakers in your desired location.
2. On the remote control, press **CALIBR**.
 - “2-CALIBRATION” is displayed on the soundbar.
 - Countdown starts from 5 to 1.
 - Calibration tone is heard. Audio calibration starts.
 - “CALIBRATING”: Calibration in progress
 - “2-DONE”: Calibration of the speaker position is completed successfully.

3. Rotate for the best listening experience.

NOTES:

- During sound calibration, all buttons on the remote control are disabled except for **POWER** and **CALIBR**.

6.3.2 Dolby Atmos® / DTS:X®

With Dolby Atmos or DTS:X, overhead audio distribution is provided for powerful 3D sound immersion.

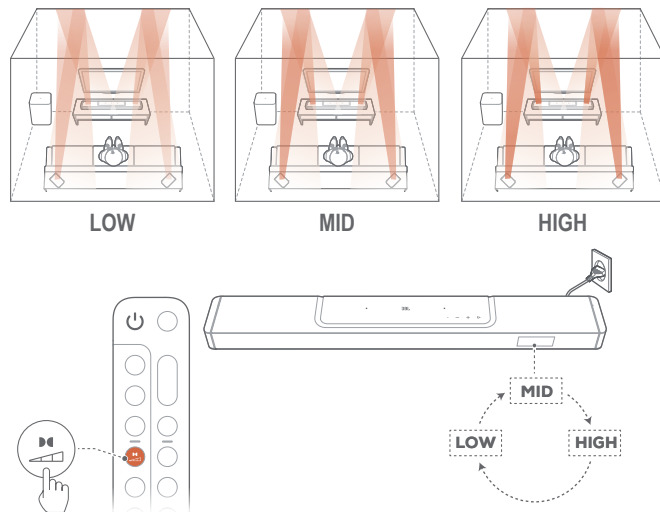

1. To play the surround sound of DOLBY ATMOS or DTS:X, connect and play your Blu-ray player or streaming device as described under “[5.1 Connection with your TV and digital devices](#)”.
2. To select suitable strength for Dolby Atmos or DTS:X, press **DOLBY/DTS** on remote control to toggle between middle (default), high, or low.

6.3.3 Rear adjustment

With both of the detachable rear speakers undocked, you can select the surround sound level.

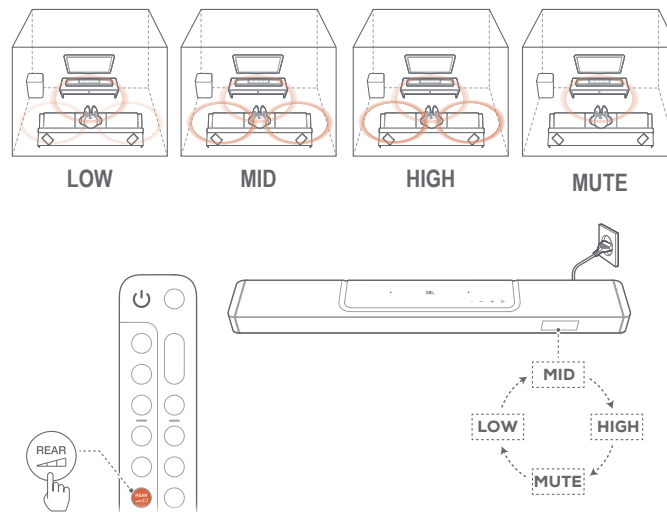

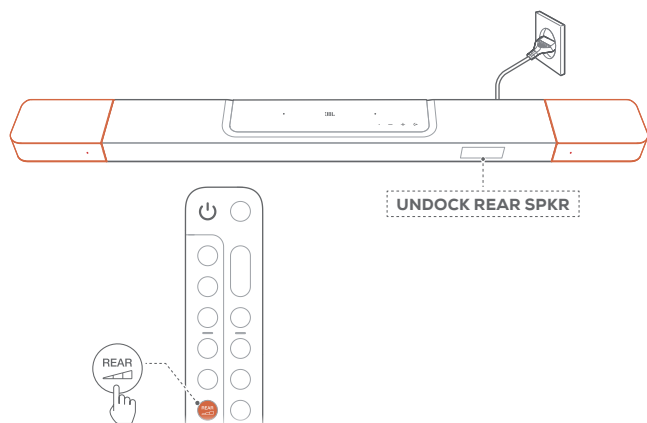

1. Check that the soundbar and the detachable rear speakers are connected wirelessly (See “6.1 Connect the detachable rear speakers and subwoofer”).
2. On the remote control, press  to toggle between surround sound levels.
 - “MID” / “HIGH” / “MUTE” / “LOW” is displayed (Default: “MID”).
 - “UNDOCK REAR SPKR” is displayed if the detachable rear speakers have been docked onto the soundbar.

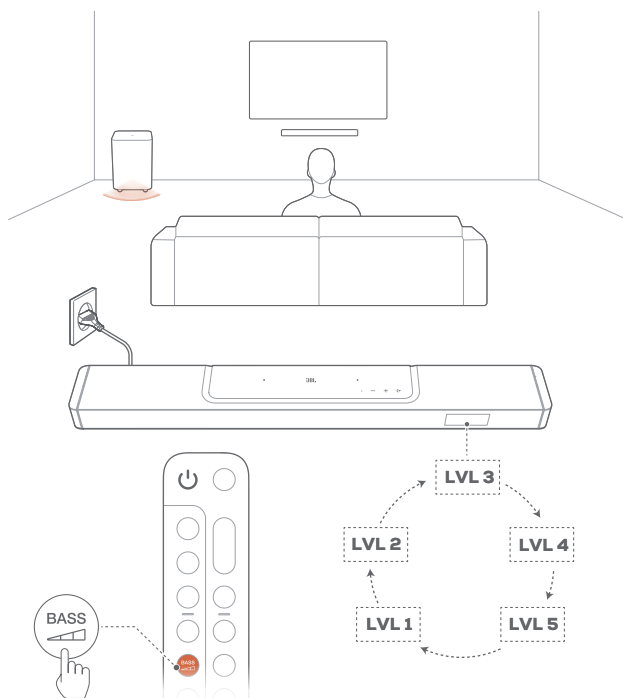

6.3.4 Bass adjustment

You can make bass adjustment as needed.



- On the remote control, press  to toggle between bass levels.
 - “LVL1” to “LVL5” is displayed (Default: “LVL3”).

6.4 Use the detachable speakers as standalone Bluetooth speakers



For music playback, you can set up the detachable rear speakers as standalone Bluetooth speakers or a Bluetooth stereo system.

6.4.1 Standalone Bluetooth speakers

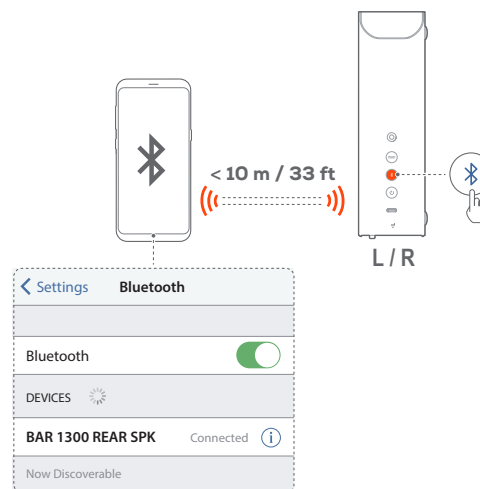
Either of the detachable rear speakers can be a standalone Bluetooth speaker.



Connect a Bluetooth device

1. On the left or right speaker, press  to switch to the Bluetooth mode.
 - : Ready for Bluetooth pairing
 - The detachable rear speaker disconnects from the soundbar.
2. On your Bluetooth device, enable Bluetooth and search for “BAR 1300 REAR SPK” within three minutes.
 - : Successful connection





3. Start audio play on your Bluetooth device.

To reconnect the last paired device





Your Bluetooth device is retained as a paired device when the speaker goes to standby mode. Next time you switch to the Bluetooth mode, the speaker reconnects the last paired device automatically.

To connect to another Bluetooth device

1. In the Bluetooth mode, press  on the left or right speaker.
 - : The speaker enters the Bluetooth pairing mode.
2. Follow the Step 2 under “[Connect a Bluetooth device](#)”.

6.4.2 Standalone Bluetooth stereo system

By connecting the two detachable speakers, you can set up a stereo music system with L (left) and R (right) channels.

1. Make sure that the left and right rear speakers are properly placed, the **L** speaker on the left and the **R** speaker on the right.
 2. Connect the two speakers:
 - a) On one speaker, press and hold  until the status indicator flashes cyan.
 - b) Within three minutes, press and hold  on the other speaker until the status indicator flashes cyan.
-  : Ready for Bluetooth Stereo pairing
→  : Bluetooth Stereo connected

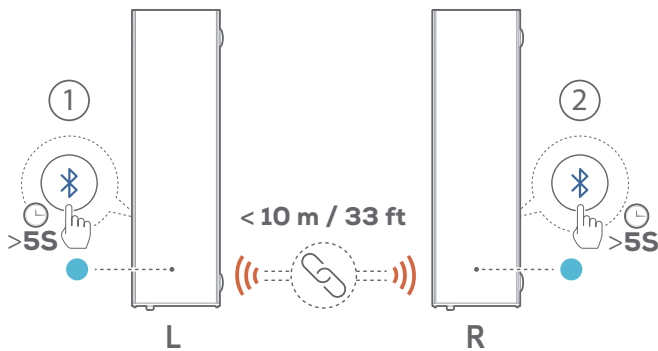

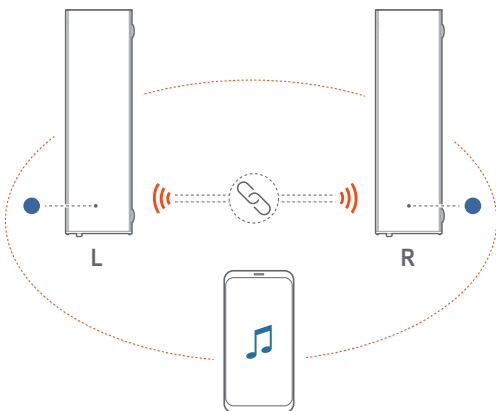

3. The two speakers start to play music from the device connected to the primary speaker.

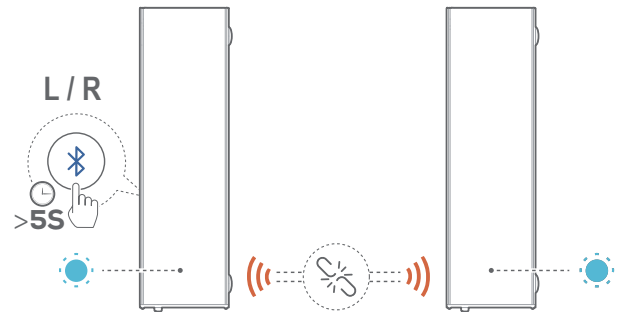

To break the Bluetooth Stereo link between the two speakers



- On either of the connected speakers, press and hold  until the status indicator flashes cyan.
 -  : You break the Bluetooth Stereo link between the two speakers.
 -  : The speakers switch to the Bluetooth pairing mode and reconnect the last paired Bluetooth device respectively.

NOTES:

- The Bluetooth connection will be lost if the distance between the soundbar and Bluetooth device exceeds 33 ft (10 m).
- Electronic devices may cause radio interference. Devices that generate electromagnetic waves must be kept away from the Soundbar, such as microwaves and wireless LAN devices.

7. PLAY

7.1 Power-on/Auto standby/Auto wakeup

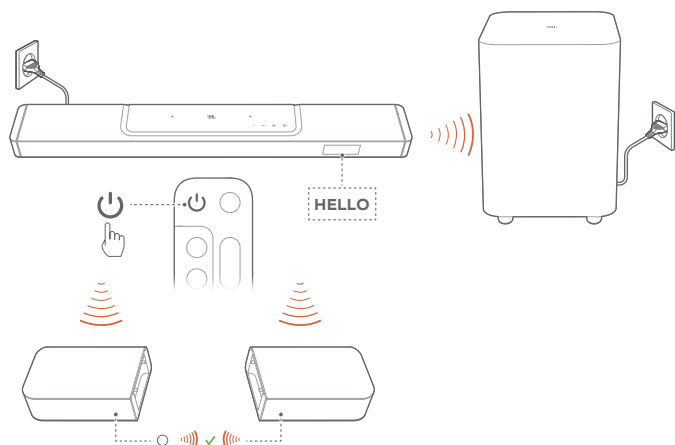

7.1.1 Switch on

- To switch on, press any button on the soundbar, or ⏻ on the remote control.
 - “HELLO” is displayed.
 - The subwoofer is reconnected to the soundbar automatically. **Connected:** 🔊 turns solid white.
 - The detachable speakers are reconnected to the soundbar automatically. **Connected:** The status indicator turns solid white (○)

7.1.2 Auto standby

If the soundbar is inactive for more than 10 minutes, it will switch to standby mode automatically. “STDBY” is displayed.

- The subwoofer also goes to standby, and 🔊 turns solid amber.
- The detachable speakers switch to standby, and the status indicator turns off for wireless connection status.
- Next time you switch on the soundbar, it returns to the last selected source.

NOTES:

- On the detachable speakers, press and hold for more than 3 seconds to switch off. To reconnect to the soundbar, press ⏻ again and then, if necessary, press 🔊 to switch to the soundbar mode.

7.1.3 Auto wakeup

In standby mode, the soundbar will wake up automatically when

- the soundbar is connected to your TV through the HDMI ARC connection and your TV is switched on;
- the soundbar is connected to your TV through the HDMI ARC connection and through the HDMI connection, is also connected to your digital device such as a set-top box, DVD/Blu-ray player or game console, and your digital device is switched on;
- the soundbar is connected to your home network and audio is streamed to the soundbar through the music streaming services over JBL One app, Chromecast built-in, AirPlay or Alexa Cast.

7.2 Play from the TV source

With the soundbar connected, you can enjoy TV audio from the soundbar speakers.

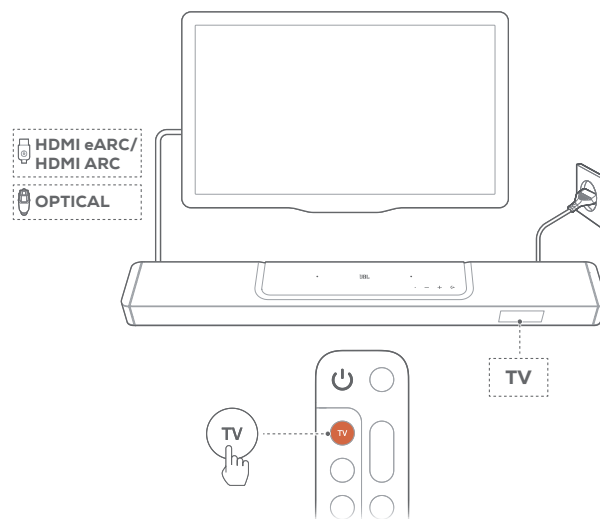

- Make sure that your TV is set to support external speakers and the built-in TV speakers are muted. Refer to the owner's manual of your TV for more information.
- Make sure that the soundbar has been properly connected to your TV (See “[5.1 Connection with your TV and digital devices](#)”).
- To select the TV source, press TV on the soundbar or **TV** on the remote control.
 - “TV”: The TV source is selected.
 - In the factory settings, the TV source is selected by default.

NOTES:

- If the soundbar is connected to your TV through both an HDMI cable and an optical cable, the HDMI cable source is selected for the TV connection.

7.2.1 TV remote control setup

To use your TV remote control for both your TV and the soundbar, check that your TV supports HDMI-CEC. If your TV does not support HDMI-CEC, follow the steps under “[TV remote control IR learning](#)”.

HDMI-CEC

If your TV supports HDMI-CEC, enable the functions as instructed in your TV user manual. You can control the volume +/-, mute/unmute, and power on/standby functions on your soundbar through the TV remote control.

TV remote control IR learning

Through IR learning, your Infra-red TV remote control can learn some commands of the soundbar.

- On the soundbar, press and hold TV and + until “LEARNING” is displayed.
 - You enter the TV remote control learning mode.

2. Point your TV remote control at the soundbar. Follow the screen instructions to operate the buttons on your TV remote control:

- When any one of “POWER”, “VOL+”, “VOL-”, or “MUTE” is displayed on the soundbar, press the desired button on your TV remote control.
 - “DONE”: The functions of the soundbar button are learnt by your TV remote control buttons.
 - The soundbar returns to the last selected source.
- To stop and exit the TV remote control learning mode, press and hold **←** and **+** on the soundbar until “EXIT LEARNING” is displayed.
 - The learnt functions are discarded.

NOTES:

- The soundbar will exit the TV remote control learning mode automatically if no action is taken for 30 seconds. The learnt functions are discarded.

7.3 Play from the HDMI IN source

With the soundbar connected as shown, your digital device can play video on your TV and audio from the soundbar speakers.

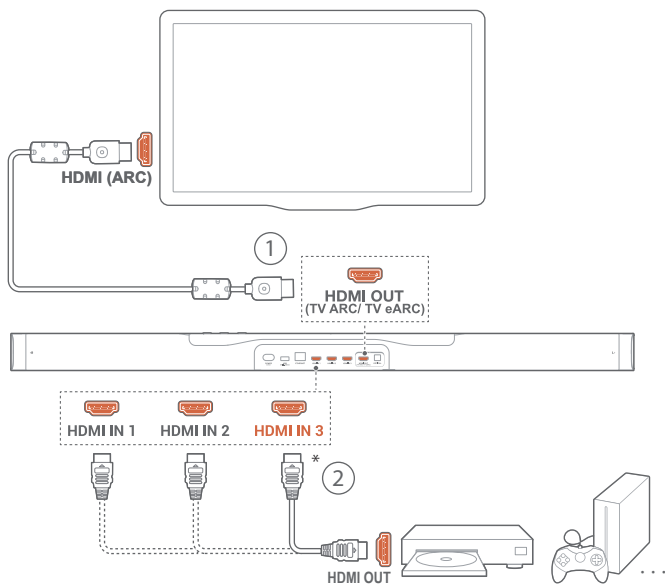

1. Make sure that the soundbar has been properly connected to your TV and digital device (See “5.1 Connection with your TV and digital devices”).
2. Switch on your digital device.
 - Your TV and the soundbar wake up from standby mode and switch to the input source automatically.
 - To select the **HDMI IN** source on the soundbar, toggle **←** on the soundbar or **HDMI** on the remote control.
3. Switch your TV to standby mode.
 - The soundbar and source device are switched to standby mode.

NOTES:

- Full compatibility with all HDMI-CEC devices is not guaranteed.

7.4 Play from the Bluetooth source

Through Bluetooth, stream audio play on your Bluetooth device to the soundbar.

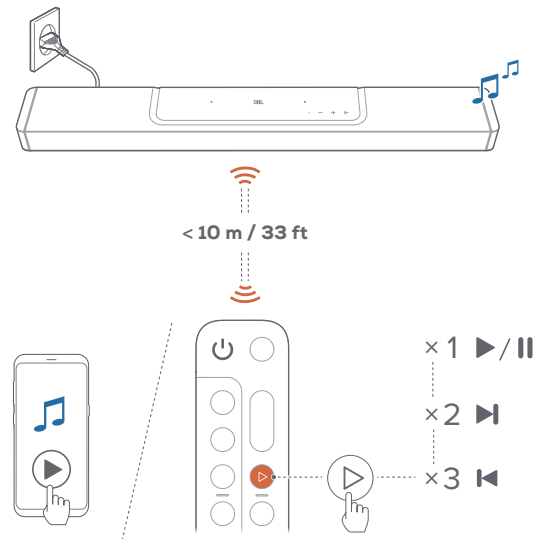

1. Check that the soundbar has been properly connected to your Bluetooth device (See “5.2 Bluetooth connection”).
2. To select the Bluetooth source, press **←** on the soundbar or **Bluetooth** on the remote control.
3. Start audio play on your Bluetooth device.
 - Alternatively, press **▶** on the remote control to control playback.
4. Adjust the volume on the soundbar, remote control or your Bluetooth device.

To use the detachable speakers as standalone bluetooth speakers or Bluetooth stereo system

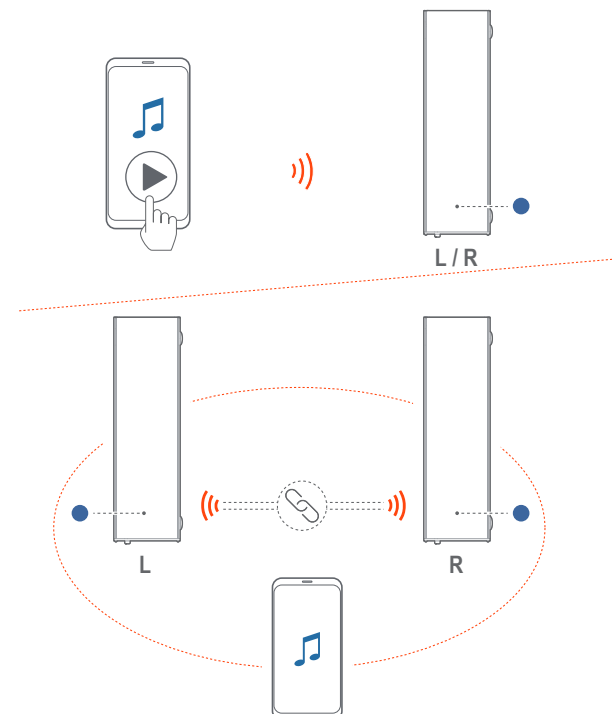

See “[6.4 Use the detachable speakers as standalone Bluetooth speakers](#)” for the information about setup and playback.

7.5 Play through the JBL One app

Through the JBL One app, stream audio from online music services to the soundbar.

- On the soundbar,
 - Check that the soundbar has been properly connected to your home network (See “[5.3 Connection with your home network](#)”).
- On your Android or iOS device,
 - Check that your Android or iOS device has been connected to the same network as the soundbar.
 - Launch the JBL One app, browse available *music streaming services to select music, and then, start music streaming to the connected soundbar.

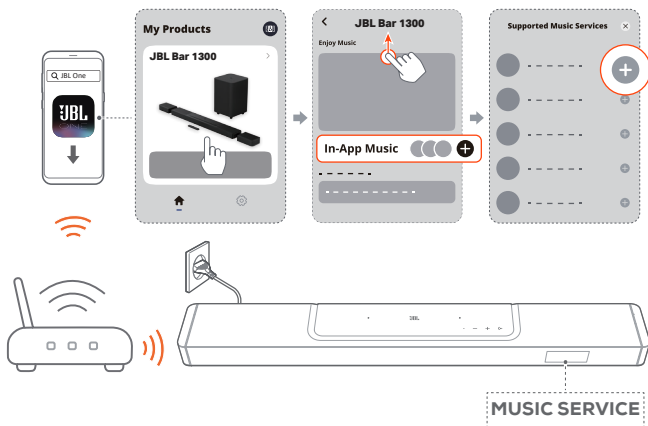



- To exit from the music playback, switch to other sources.

NOTES:

- *Subscription may be needed and not provided by the JBL One app.

Access your presets with the Moment button

By pressing  on the remote control, you can access the playlist and speaker settings that you have personalized on the JBL One app.

- On the JBL One app,
 - personalize the  (Moment) feature.

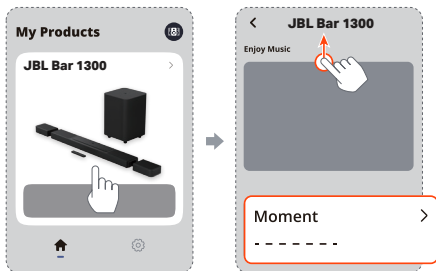

- On the soundbar,
 - press  on the remote control to access the personalized playlist and speaker settings.

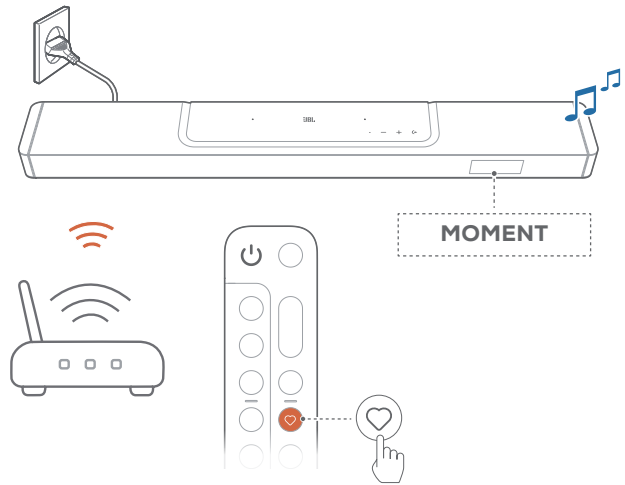

7.6 Play through Chromecast built-in

Through Chromecast built-in, stream audio on your Android or iOS device to the soundbar.

- On the soundbar,
 - Check that the soundbar has been properly connected to your home network (See “[5.3 Connection with your home network](#)”).
- On your Android or iOS device,
 - Check that your Android or iOS device has been connected to the same network as the soundbar.
 - Launch the JBL One app, and check that you have enabled the streaming service of Chromecast built-in.

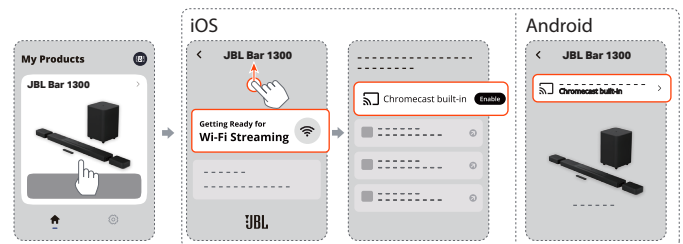

- c) On a Chromecast-enabled app, play music, tap the cast icon  and select the connected soundbar.



3. To exit from the music playback, switch to other sources.

7.7 Play through AirPlay

Through AirPlay, stream audio on your iOS device to the soundbar.

1. On the soundbar,
 - Check that the soundbar has been properly connected to your home network (See [“5.3 Connection with your home network”](#)).
2. On your iOS device,
 - a) Check that your iOS device has been connected to the same network as the soundbar.
 - b) To enter the Control Center on an iOS device, swipe down from the upper right corner. Tap  to select the connected soundbar and then, start audio streaming from an app.

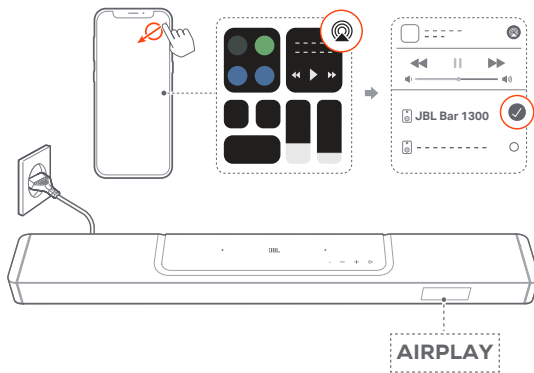

3. To exit from the music playback, switch to other sources.

7.8 Play through Alexa Cast

With Alexa Cast, you can stream music from the Amazon Music library to the soundbar.

1. Check that the soundbar has been properly connected to your home network (See [“5.3 Connection with your home network”](#)).

2. On your Android or iOS device,
 - a) Check that your Android or iOS device has been connected to the same network as the soundbar.
 - b) Launch the JBL one app, and check that you have enabled the streaming service of Amazon Alexa.

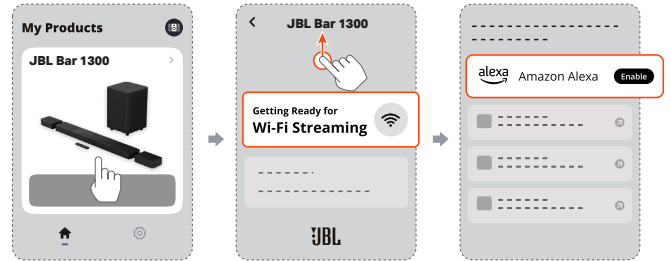

3. Launch the Amazon Alexa app to start music playback.

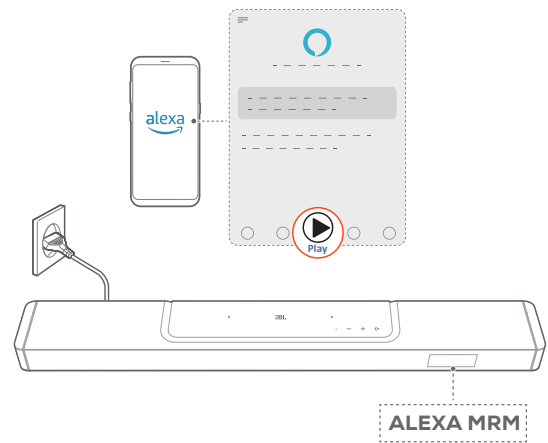

- Open the Amazon Music app to access the Amazon Music library.
- Make sure that you start music playback from the same Alexa account that you have enabled in the JBL One app. Refer to the Amazon Alexa app for more details.

NOTES:

- The soundbar can support audio streaming and cannot support video streaming.
- During playback through Chromecast built-in, AirPlay or Alexa Cast, music playback pauses on the current connected device when you start music playback on a second connected device.
- When the soundbar switches between your home Wi-Fi and wired network during AirPlay, music playback pauses and will resume in a few minutes, depending on the bandwidth condition of broadband. For the connection to your home wired network, see [“5.3 Connection with your home network”](#).

7.9 Multi-room playback

With the multi-room playback, you can stream music on your Android or iOS device to multiple Chromecast-enabled/ AirPlay / Alexa-enabled speakers.

7.9.1 Chromecast built-in

1. Through the Google Home app, connect multiple Chromecast-enabled speakers to the same network, assign them to multiple rooms, and create groups as needed.
2. Run a Chromecast-enabled app on your smartphone or tablet.
3. Play music. Press  and select the grouped speakers.

NOTES:

- To create a multi-room speaker group in the Google Home app, make sure that you have connected all the speakers to the same home network and have used the same Google login account. Refer to the Google Home app for more details.
- Depending on the bandwidth of your local network, you can stream music to up to 6 Chromecast-enabled speakers.

7.9.2 AirPlay

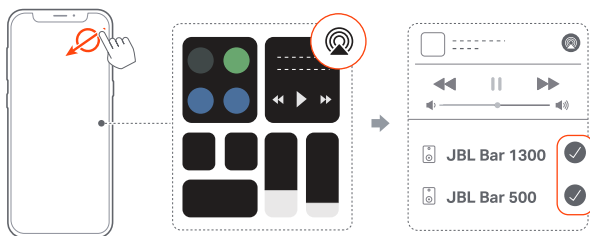

1. On an iOS device, enter the Control Center.
2. Tap  to select multiple connected speakers as needed.
3. Start music streaming from an app.

7.9.3 Alexa MRM: Multi-Room Music

1. Check that you have enabled the streaming service of Amazon Alexa on the soundbar through the JBL One app.



2. Through the Amazon Alexa app, create a Multi-room Music group for the soundbar. Refer to the Amazon Alexa app for more information.

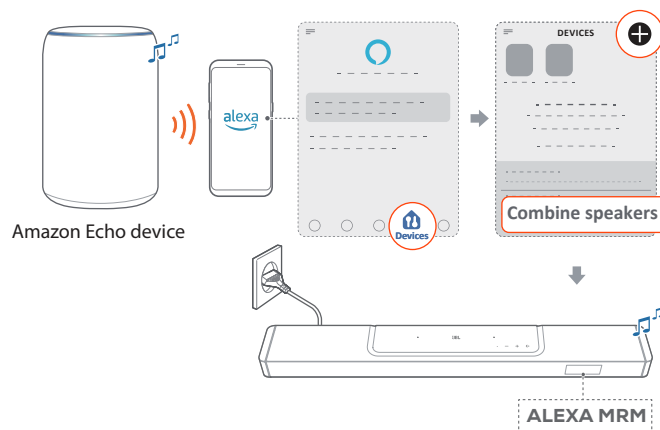

NOTES:

- To create a multi-room music group in the Amazon Alexa app, make sure that you have connected all the devices to the same home network and have used the same Alexa login account. Refer to the Amazon Alexa app for more details.

8. SOUND SETTINGS

8.1 Audio sync

With the audio sync function, you can synchronize audio and video to make sure that no delay is heard from your video content.

1. On the remote control, press and hold **TV** for more than three seconds and then, press **+**.
→ “**SYNC**” is displayed.
2. Within five seconds, press **+** or **-** on the remote control to adjust the audio delay and match with video.
→ The audio sync timing is displayed.

8.2 Smart mode

With the smart mode enabled by default, you can enjoy TV programs with rich sound effects. For TV programs such as news and weather forecasts, you can reduce sound effects by disabling the smart mode and switching to the standard mode.

Smart mode: EQ settings and JBL Surround Sound are applied for rich sound effects.

Standard mode: The preset EQ settings are applied for standard sound effects.

To disable the smart mode, do the following:

- On the remote control, press and hold  for more than three seconds and then, press **+**.
→ You switch to another mode. “**OFF SMART MODE**”: The standard mode is enabled.
→ Next time you switch on the soundbar, the smart mode is **enabled again automatically**.

9. RESTORE FACTORY SETTINGS

By restoring the default settings defined at factories, you remove all your personalized settings from the soundbar.

- On the soundbar, press and hold , **+** and **-** for more than 5 seconds.
→ “**RESET**” is displayed.
→ The soundbar restarts.

10. SOFTWARE UPDATE

For optimal product performance and your best user experience, JBL may offer software updates for the soundbar system in the future.

Updating online

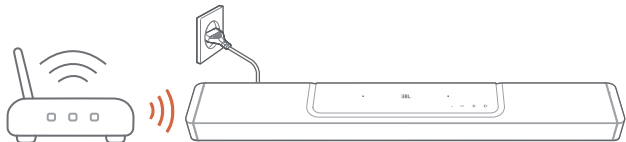

- Connect the soundbar to your home network. Updating online happens automatically if software updates are available.
 - **“WAIT”**: Software updating in progress
 - **“DONE”**: Software updating completed

NOTES:

- Software updates will be synchronized to the two detachable speakers when they are connected to or docked onto the soundbar.

11. RE-CONNECT THE SUBWOOFER

The soundbar and subwoofer are paired at factories. After power-on, they are paired and connected automatically. In some special cases, you may need to pair them again.

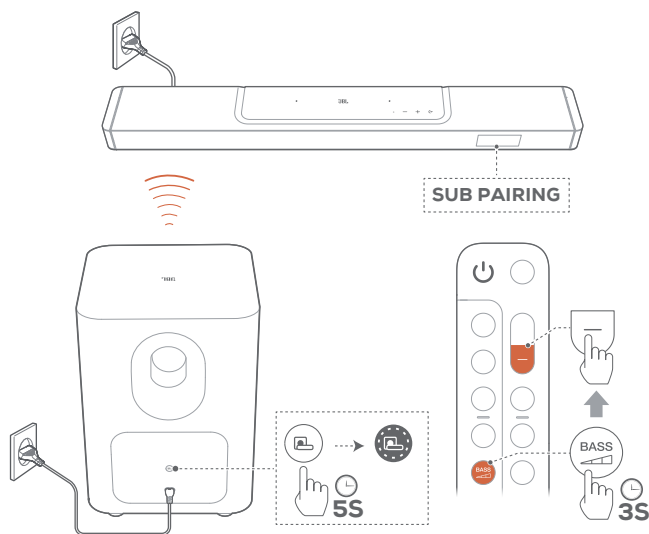

To re-enter the subwoofer pairing mode

1. On the rear panel of subwoofer, press and hold until it turns fast flashing white.
2. To enter the subwoofer pairing mode on the soundbar, press and hold on the remote control for more than three seconds. Then, press on the remote control.
 - **“SUB PAIRING”**: The subwoofer is ready for pairing.
 - **“SUB PAIRED”**: The subwoofer is connected.

NOTES:

- The subwoofer will exit the pairing mode in three minutes and go to standby, if pairing is not completed. turns from fast flashing white to off. To return to the pairing mode, press .

12. PRODUCT SPECIFICATIONS

General specification:

- Model: BAR 1300 (soundbar unit)
BAR 1300 SURROUND (detachable speaker)
BAR 1300 SUB (subwoofer unit)
- Sound system: 11.1.4 channel
- Power supply: 100 - 240V AC, ~ 50/60Hz
- Total speaker power output (Max @THD 1%): 1170W
- Soundbar output power (Max @THD 1%): 650W
- Surround speaker output power(Max @THD 1%): 2x 110W
- Subwoofer output power (Max. @THD 1%): 300W
- Soundbar transducer: 6x (46x90)mm racetrack drivers, 5x 0.75" (20mm) tweeters, 4x 2.75" (70mm) up-firing full-range drivers
- Surround speaker transducer: (46x90)mm racetrack driver, 0.75" (20mm) tweeter, 2.75" (70mm) up-firing full-range driver, 2x (48x69mm) rounded rectangle Passive Radiators
- Subwoofer transducer: 10" (260mm)
- Networked standby power: < 2.0 W
- Operating temperature: 0 °C - 45 °C
- Lithium battery: 3.635V, 6600mAh
- Detachable surround speaker playtime: up to 10 Hours (may vary according to content type and volume level)

HDMI specification

- HDMI video input: 3
- HDMI video output (with Enhanced Audio Return Channel, eARC): 1
- HDMI HDCP version: 2.3
- HDR pass through: HDR10, Dolby Vision

Audio specification

- Frequency response: 33Hz - 20kHz (-6dB)
- Audio inputs: 1 Optical, Bluetooth, USB (USB playback is available in US and APAC version. For other versions, USB is for Service only.)

USB specification (Audio playback is for US version only)

- USB port: Type A
- USB rating: 5V DC, 0.5A
- Supporting file formats: mp3
- MP3 codec: MPEG 1 Layer 2/3, MPEG 2 Layer 3, MPEG 2.5 Layer 3
- MP3 sampling rate: 16 - 48 kHz
- MP3 bitrate: 80 - 320 kpbs

Wireless specification

- Bluetooth version: Main bar - 5.3, Detachable surround speaker - 5.3
- Bluetooth profile: Main bar - A2DP 1.2 and AVRCP 1.5, Detachable surround speaker - A2DP 1.3 and AVRCP 1.6
- Bluetooth transmitter frequency range: 2400 MHz - 2483.5 MHz

- Bluetooth transmitter power: <15 dBm (EIRP)
- Wi-Fi network: IEEE 802.11 a/b/g/n/ac/ax (2.4GHz/5GHz)
- 2.4G Wi-Fi transmitter frequency range: 2412 - 2472 MHz (2.4 GHz ISM Band, USA 11 Channels, Europe and others 13 Channels)
- 2.4G Wi-Fi transmitter power: <20dBm (EIRP)
- 5G Wi-Fi transmitter frequency range: 5.15 - 5.35GHz, 5.470 - 5.725GHz, 5.725 - 5.825GHz
- 5G Wi-Fi transmitter power: 5.15 - 5.25GHz <23dBm, 5.25 - 5.35GHz & 5.470 - 5.725GHz <20dBm, 5.725 - 5.825GHz <14dBm (EIRP)
- 2.4G wireless transmitter frequency range: 2406 - 2474 MHz
- 2.4G wireless transmitter power: <10 dBm (EIRP)

Dimensions

- Total soundbar dimensions (W x H x D): 1376 x 60 x 139 mm / 54.2" x 2.4" x 5.5"
- Main soundbar dimensions (W x H x D): 1000 x 60 x 139 mm / 39.4" x 2.4" x 5.5"
- Detachable surround speaker dimensions (each) (W x H x D): 202 x 60 x 139 mm / 8" x 2.4" x 5.5"
- Subwoofer dimensions (W x H x D): 305 x 440.4 x 305 mm / 12" x 17.3" x 12"
- Soundbar weight: 4.3kg / 9.5 lbs
- Detachable surround speaker weight (each): 1.17 kg / 2.57 lbs
- Subwoofer weight: 10 kg / 22 lbs
- Packaging dimensions (W x H x D): 381 x 1107 x 477 mm / 15" x 43.6" x 18.8"
- Packaging Weight: 21.45 kg / 47.2 lbs

13. TROUBLESHOOTING

Never try to repair the product yourself. If you have problems using this product, check the following points before you request services.

System

The unit will not turn on.

- Check if the power cord is plugged into power and the soundbar.

The soundbar has no response to button pressing.

- Restore the soundbar to factory settings (See "[9. RESTORE FACTORY SETTINGS](#)").

Sound

No sound from soundbar

- Make sure that the soundbar is not muted.
- Select the correct audio input source on the remote control.
- Connect the soundbar to your TV or other devices properly
- Restore the soundbar to its factory settings by pressing and holding **⏪**, **+** and **-** on the soundbar for more than 5 seconds.

Distorted sound or echo

- If you play audio from your TV through the soundbar, make sure that your TV is muted or the built-in TV speaker is disabled.

Audio and video are not synchronized.

- Enable the audio sync function to synchronize audio and video (See "[8.1 Audio sync](#)").

No height sound effects of Dolby Atmos

- If your TV supports HDMI ARC only, make sure that you have connected your digital device to the soundbar through the **HDMI IN** connector on the soundbar (See "[5.1.1 TV \(HDMI ARC / eARC\)](#)")
- Enjoy the sound effects of Dolby Atmos when you play movies from the TV / HDMI source. For audio streaming over Bluetooth or casting apps (enabled by Chromecast built-in, AirPlay or Alexa Cast), Dolby Atmos is not supported.

Bluetooth

A device cannot be connected with the soundbar.

- Check if you have enabled Bluetooth on the device.
- If the soundbar has been paired with another Bluetooth device, reset Bluetooth (see "[5.2.3 To connect to another Bluetooth device](#)").
- If your Bluetooth device has ever been paired with the soundbar, reset Bluetooth on the soundbar, unpair the soundbar on the Bluetooth device, and then, pair the Bluetooth device with the soundbar again (see "[5.2.3 To connect to another Bluetooth device](#)").

Poor audio quality from a connected Bluetooth device

- The Bluetooth reception is poor. Move the source device closer to the soundbar, or remove any obstacle between the source device and the soundbar.

The connected Bluetooth device connects and disconnects constantly.

- The Bluetooth reception is poor. Move the source device closer to the soundbar, or remove any obstacle between the source device and the soundbar.

Wi-Fi

Failed to connect to Wi-Fi.

- Make sure that Wi-Fi is turned on.
- Make sure that you have selected the right network and entered the correct password.
- Make sure that your router or modem is turned on and within the range.
- In your router settings, make sure that you have set the security type to WPA2 or auto.
- Make sure that your soundbar is connected to the same wireless LAN as your smartphone or tablet.
- If you have difficulties in setting up Wi-Fi, hold **+** and **-** on the soundbar until "**SETUP WIFI**" is displayed.

Playback

AirPlay cannot find the soundbar as an AirPlay speaker for music streaming.

- On your Apple device, update the software to the latest version: iOS 13.4 and later, Mac OS 10.15.4 and later, or TV OS 14.3.
- Make sure that your Apple device has been connected to the same network as the soundbar.
- For a PC running iTunes for Windows, you can stream music from your PC to the soundbar through Bluetooth.

Music playback does not work smoothly when the sound source switches from Bluetooth to Chromecast built-in, AirPlay or Alexa Cast.

- The quality of audio casting and playback are dependent on the traffic and coverage of the network that connects the soundbar and your casting devices, such as phones, tablets and PCs.

Music playback does not resume when the sound source switches from Bluetooth to TV/HDMI IN, and then back to Bluetooth.

- The music playback in the Bluetooth device stops when the sound source switches from Bluetooth to TV / HDMI IN. When you switch back to the Bluetooth source, start music playback in the Bluetooth device again.

The soundbar is in the "Offline" status in the Amazon Alexa app or issues happen to Alexa MRM-related playback.

- To recover the soundbar, restore the soundbar to its factory settings by pressing and holding **⏪**, **+** and **-** for more than 5 seconds.

Remote control

The remote control does not work.



- Check if the batteries are drained. If so, replace them with new ones.
- Reduce the distance and angle between the remote control and the main unit.

Failed to complete the TV remote control learning.

- Check if you are using an infra-red TV remote control. The IR learning is not supported by a Bluetooth TV remote control.

Low power standby mode

The soundbar cannot enter the low power standby mode when it completes the power charging of detachable speakers.

- To enter the low power standby mode, press and hold  on the remote control until "CEC 1" is displayed on the soundbar; then, press and hold  on the remote control again until "CEC 2" is displayed.
- To exit the low power standby mode, unplug the power cord and then, plug it again.

14. TRADEMARKS



The Bluetooth® word mark and logos are registered trademarks owned by Bluetooth SIG, Inc. and any use of such marks by HARMAN International Industries, Incorporated is under license. Other trademarks and trade names are those of their respective owners.



The terms HDMI, HDMI High-Definition Multimedia Interface, HDMI trade dress and the HDMI Logos are trademarks or registered trademarks of HDMI Licensing Administrator, Inc.



Wi-Fi CERTIFIED 6™ and the Wi-Fi CERTIFIED 6™ Logo are trademarks of Wi-Fi Alliance®.

COMPATIBLE WITH



Dolby, Dolby Vision, Dolby Atmos, and the double-D symbol are registered trademarks of Dolby Laboratories Licensing Corporation. Manufactured under license from Dolby Laboratories. Confidential unpublished works. Copyright © 2012–2021 Dolby Laboratories. All rights reserved.



For DTS patents, see <http://patents.dts.com>. Manufactured under license from DTS, Inc. DTS, DTS:X, and the DTS:X logo are registered trademarks or trademarks of DTS, Inc. in the United States and other countries. © 2021 DTS, Inc. ALL RIGHTS RESERVED.



Google, Android, Google Play, Chromecast built-in, and Google Home are trademarks of Google LLC.

Google Assistant is not available in certain languages or countries.



Use of the Works with Apple badge means that an accessory has been designed to work specifically with the technology identified in the badge and has been certified by the developer to meet Apple performance standards.

Apple, and AirPlay are trademarks of Apple Inc., registered in the U.S. and other countries and regions.

To use AirPlay with JBL BAR 1300, the latest version of iOS, iPadOS, or macOS is recommended.



Amazon, Alexa, and all related marks are trademarks of Amazon.com, Inc. or its affiliates.



Use your phone, tablet or computer as a remote control for Spotify. Go to spotify.com/connect to learn how. The Spotify Software is subject to third party licenses found here: <https://www.spotify.com/connect/third-party-licenses>

15. OPEN SOURCE LICENSE NOTICE

This product contains open source software licensed under GPL. For your convenience, the source code and relevant build instruction are also available at https://harman-webpages.s3.amazonaws.com/JBL_BAR_Gen3_package_license_list.htm

Please feel free to contact us at:

Harman Deutschland GmbH

HATT: Open Source, Gregor Krapf-Gunther,
Parkring 3 85748 Garching bei Munchen, Germany

or OpenSourceSupport@Harman.com if you have additional question regarding the open source software in the product.



HARMAN International Industries,
Incorporated 8500 Balboa Boulevard,
Northridge, CA 91329 USA
www.jbl.com

© 2024 HARMAN International Industries, Incorporated.
All rights reserved.

JBL is a trademark of HARMAN International Industries, Incorporated, registered in the United States and/or other countries. Features, specifications and appearance are subject to change without notice.